



**TRANSFORMER BOBBIN  
INDUSTRIAL CO.,LTD.**

Tel : 86-769-88789999 Fax : 86-769-88789989  
http:// tbi-tw.com e-mail : tb6688@ms46.hinet.net

REVISIONS

REV	SYM	DRAFTER	CHECKER	DATE
①		G.F.YANG	W.H.HSU	09/02/10
②		G.F.YANG	W.H.HSU	09/03/10
③		YAN.TANG	G.F.YANG	10/26/10

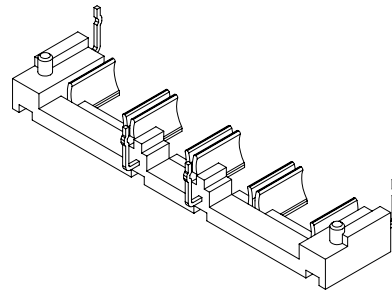
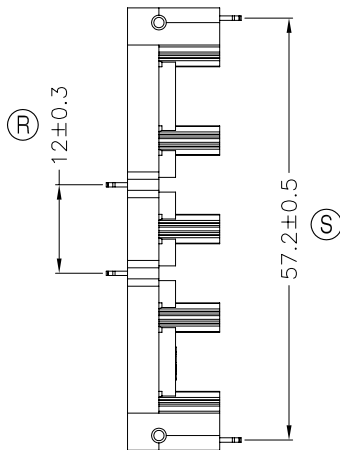
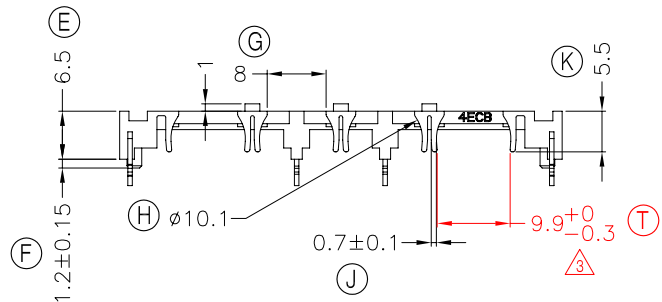
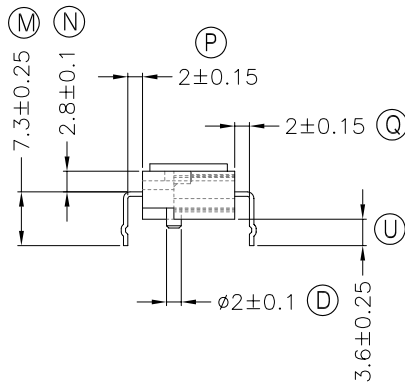
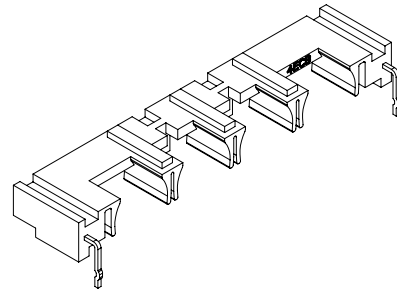
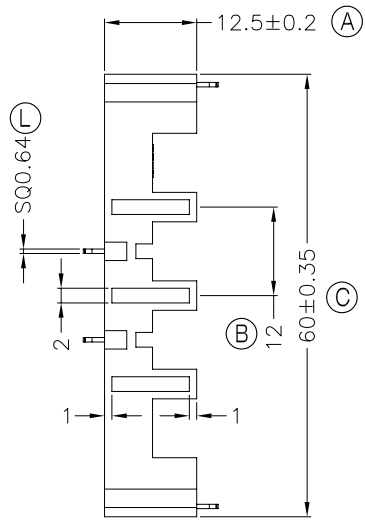

DWG NO. 4ECB-CAP-4P-TL-0H-75

PART NO.	MATERIAL (BOBBIN)	MATERIAL (TERMINAL)	TERMINAL (PLATING)	PIN ALLOCATION	NOTE
----------	-------------------	---------------------	--------------------	----------------	------

TBI-220-24081.7506	Nylon HTN FR52G30NH(BK)	CP WIRE	Sn	ALL PIN	S.C
					H.C

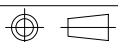

TOLERANCE: ±0.2

UNIT : m / m

SCALE 1 : 1

Finish: 1. PB wire Immersion Sn on terminal : Thickness:Sn plating,100,5 μm (200 μ inches) min,Base nickel 0.625 μm (25 μ inches) min.  
2. CP wire Immersion Sn on terminal : Thickness:Sn plating,100,5 μm (200 μ inches) min.  
3. Coplanarity deviation: 0.10 mm (0.004 inches )max.

REV 3