

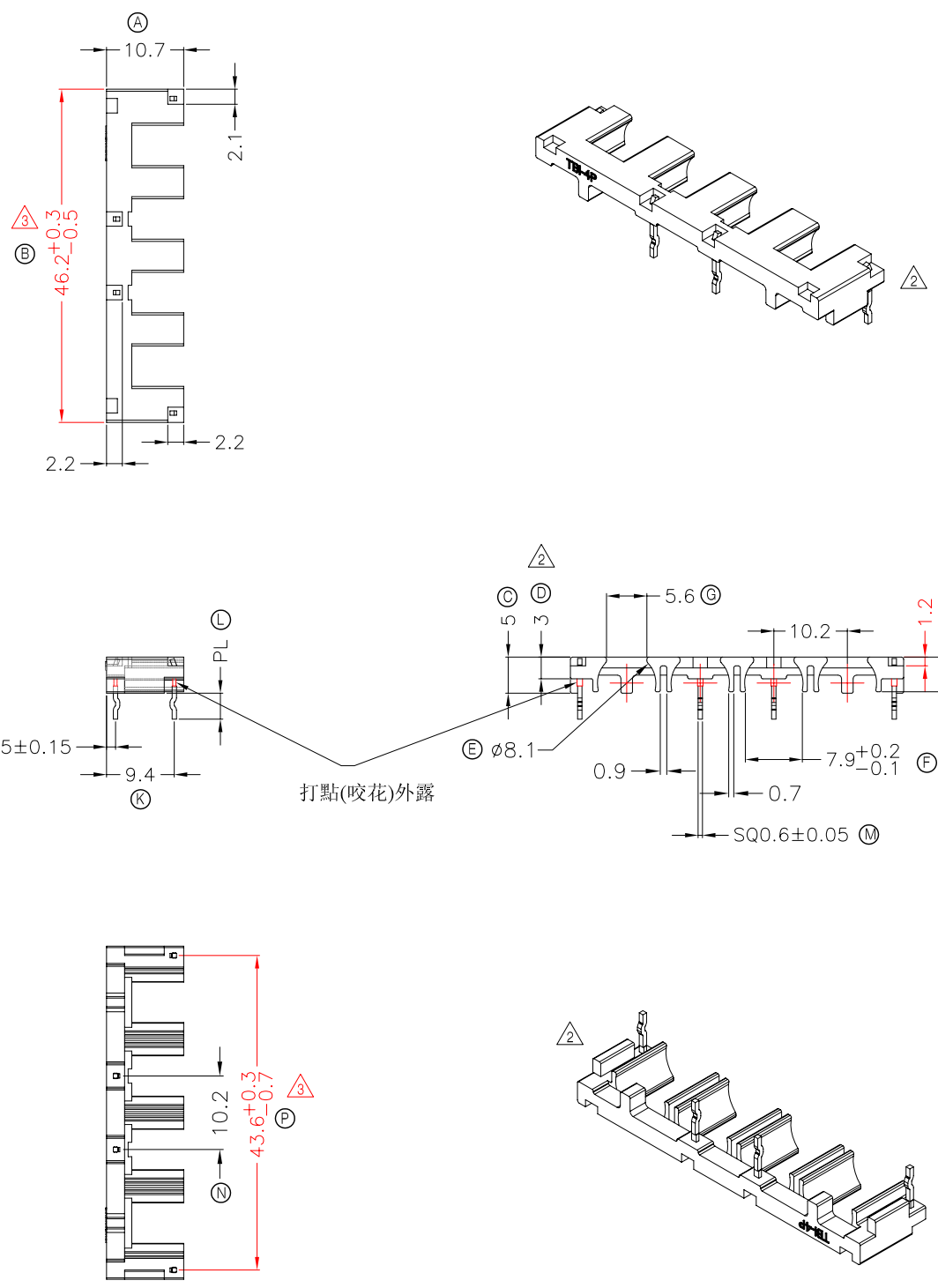

**TRANSFORMER BOBBIN INDUSTRIAL CO.,LTD.**

Tel : 86-769-88789999 Fax : 86-769-88789989  
 http:// tbi-tw.com e-mail : tb6688@ms46.hinet.net

REVISIONS				
REV	SYM	DRAFTER	CHECKER	DATE
①		X.H.GU	G.F.YANG	01/17/13
②		F.LU	G.F.YANG	03/26/13
③		X.H.GU	G.F.YANG	12/17/13



DWG NO.	4CAP-4P-TH-A1-75				
PART NO.	MATERIAL (BOBBIN)	MATERIAL (TERMINAL)	TERMINAL (PLATING)	PIN ALLOCATION	NOTE
TBI-220-24111.7506	Nylon HTN FR52G30NH(BK)	CP WIRE	Sn	ALL PIN PL=3.6±0.3	S
TBI-220-24111.7516	Nylon HTN FR52G30NH(BK)	CP WIRE	Sn	ALL PIN PL=3.3±0.3	

TOLERANCE: 0<L<=4: ±0.1 4<L<=16: ±0.2 16<L<=: ±0.3 UNIT : m / m SCALE 1 : 1

Finish: 1. PB wire Immersion Sn on terminal : Thickness:Sn plating,100,5 μm (200 μ inches) min,Base nickel 0.625 μm (25 μ inches) min.  
 2. CP wire Immersion Sn on terminal : Thickness:Sn plating,100,5 μm (200 μ inches) min.  
 3. Coplanarity deviation: 0.10 mm (0.004 inches )max.

REV 3



**TRANSFORMER BOBBIN INDUSTRIAL CO.,LTD.**

Tel : 86-769-88789999 Fax : 86-769-88789989  
 http:// tbi-tw.com e-mail : tb6688@ms46.hinet.net

REVISIONS				
REV	SYM	DRAFTER	CHECKER	DATE
①		X.H.GU	G.F.YANG	01/17/13
②		F.LU	G.F.YANG	03/26/13
③				

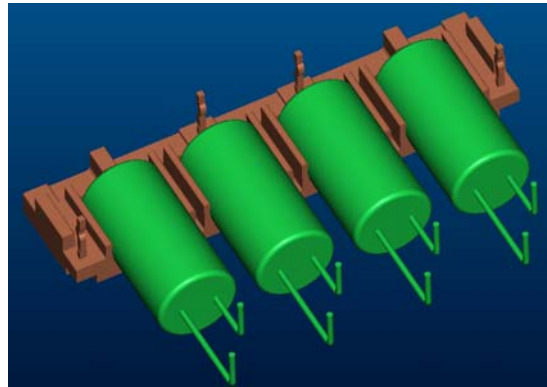
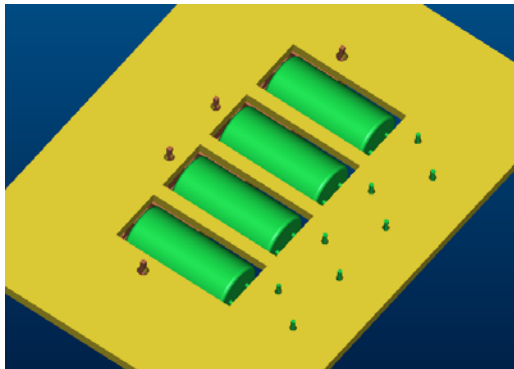
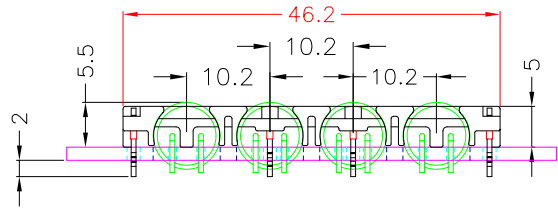
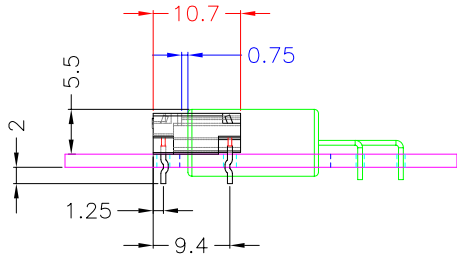
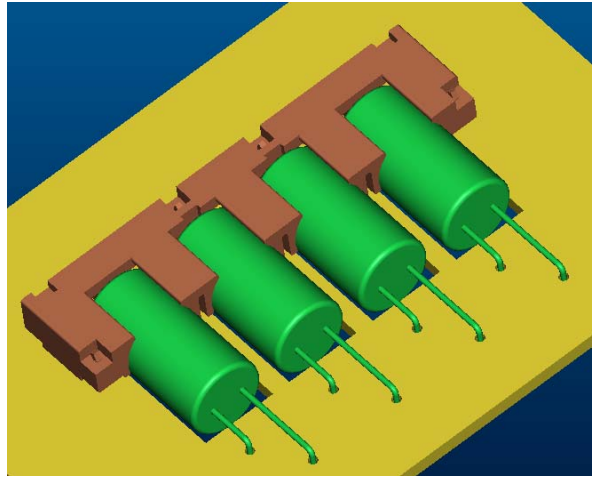
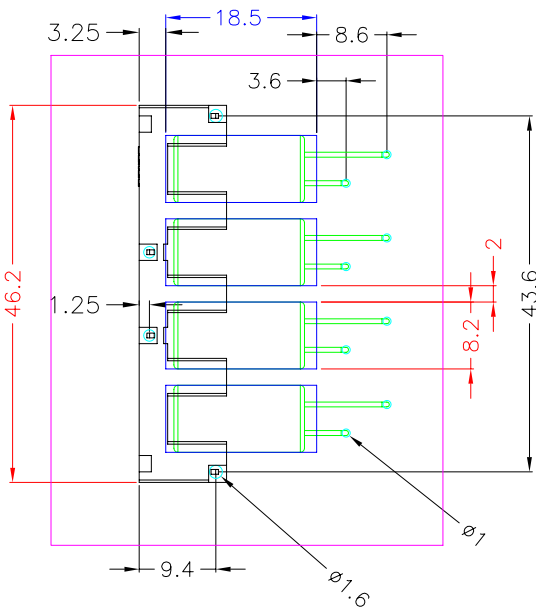

DWG NO. 4CAP-4P-TH-A1-75-ASM

PART NO. MATERIAL (BOBBIN) MATERIAL (TERMINAL) TERMINAL (PLATING) PIN ALLOCATION NOTE

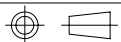
TOLERANCE: 0<L<=4: ±0.1 4<L<=16: ±0.2 16<L<=: ±0.3

UNIT : m/m

SCALE 1:1

REV 2